



## data ventilátoru

21. 4. 2020

verze FANselect V 1.01 (200311), AMCA V 1.03 February, 2019 / 1.20.03.11 | 541 |

1



typ	FN091-ZIQ.GL.A5P1
artiklové č.	183920   Portfolio STD-WW

## technická data

motor	ECblue
napájení	-
maximální okolní teplota ( $t_r$ )	°C
účinnost $\eta_{statA}$	%
účinnost $N_{actual}$   $N_{SOLL}$	
ErP - třída	
grille   influence	

## data ventilátoru

otáčky ventilátoru ( $n$ )   max. ( $n_{max}$ )	1/min	-   1100
frekvence v prac.bodě ( $f_{DP}$ )   ( $f_{max}$ )	Hz	50   60
hmotnost výrobku ( $m_{Pr}$ )	kg	55.7
zástavbové rozměry zohledněny ( $\check{S}$ x V x H)	mm	1870 x 1230 x 2000

PF:PF\_50; Ano:183920; STol:+-10 %



## charakteristika / hlučnost

21. 4. 2020

verze FANselect V 1.01 (200311), AMCA V 1.03 February, 2019 / 1.20.03.11 | 541 |

1

**FN091-ZIQ.GL.A5P1**

Measured in full nozzle with pressure side guard grille in air flow direction V in installation type A according to ISO5801

183920 | Portfolio STD-WW

měřená hustota 1.16 [kg/m³]

### vzduchový výkon $p_{sF}$

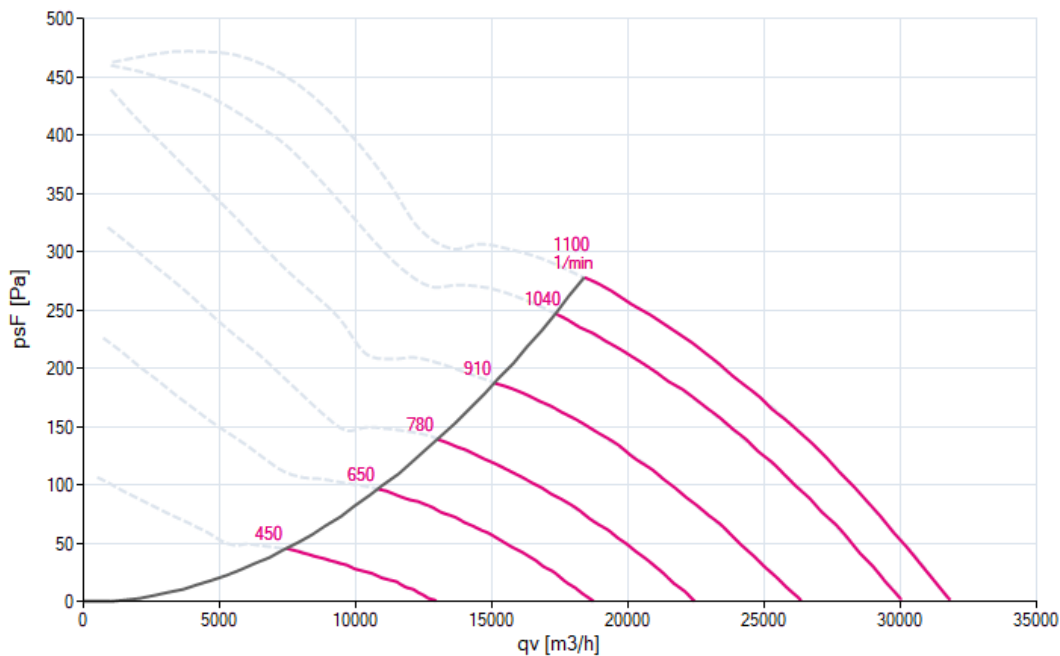

### hlučnost ( $L_{w(A),5}$ )

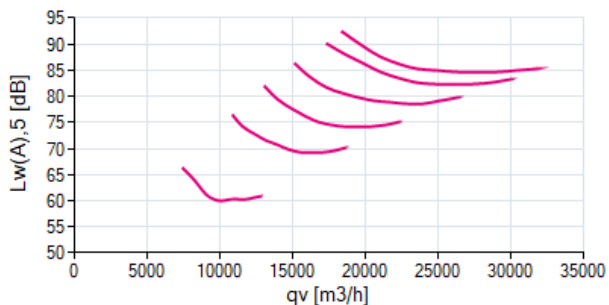

### hlučnost ( $L_{w(A),6}$ )

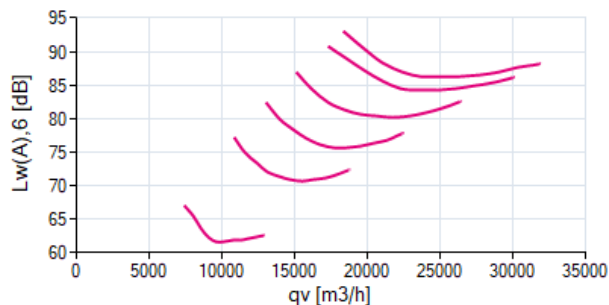

**1 FN091-ZIQ.GL.A5P1**

f [Hz]	sum	63	125	250	500	1000	2000	4000	8000
$L_{w(A),5}$	-	-	-	-	-	-	-	-	-
$L_{w,5}$	-	-	-	-	-	-	-	-	-

f [Hz]	sum	63	125	250	500	1000	2000	4000	8000
$L_{w(A),6}$	-	-	-	-	-	-	-	-	-
$L_{w,6}$	-	-	-	-	-	-	-	-	-

1

FN091-ZIQ.GLA5P1

Measured in full nozzle with pressure side guard grille in air flow direction V in installation type A according to ISO5801

183920 | Portfolio STD-WW

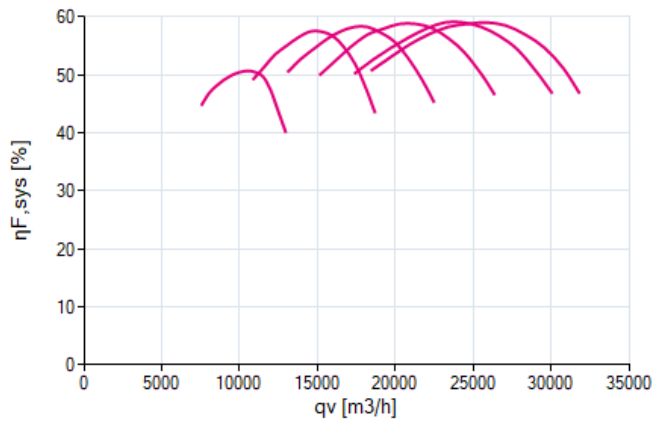
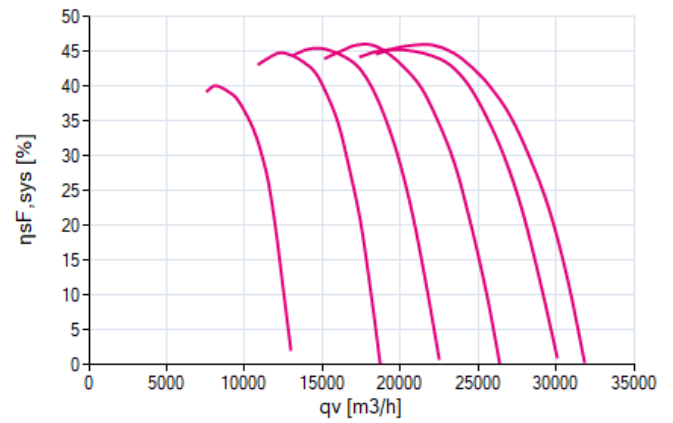
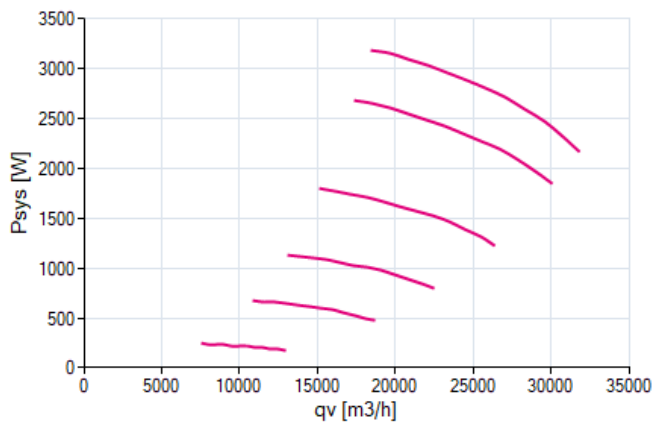
měřená hustota 1.16 [kg/m<sup>3</sup>]účinnost  $\eta_{F,sys}$ účinnost  $\eta_{SF,sys}$ příkon  $P_{sys}$ 



## nominální hodnoty

21. 4. 2020

verze FANselect V 1.01 (200311), AMCA V 1.03 February, 2019 / 1.20.03.11 | 541 |

1



**FN091-ZIQ.GL.A5P1**

183920

3~ 380-480V 50Hz P1 3.20kW  
 5.00-3.90A 1100/MIN 60°C  
 3~ 380-480V 60Hz P1 3.20kW  
 5.00-3.90A 1100/MIN 60°C  
 IP55 THCL155

## výkres

21. 4. 2020

verze FANselect V 1.01 (200311), AMCA V 1.03 February, 2019 / 1.20.03.11 | 541 |

1



**FN091-ZIQ.GL.A5P1**

183920

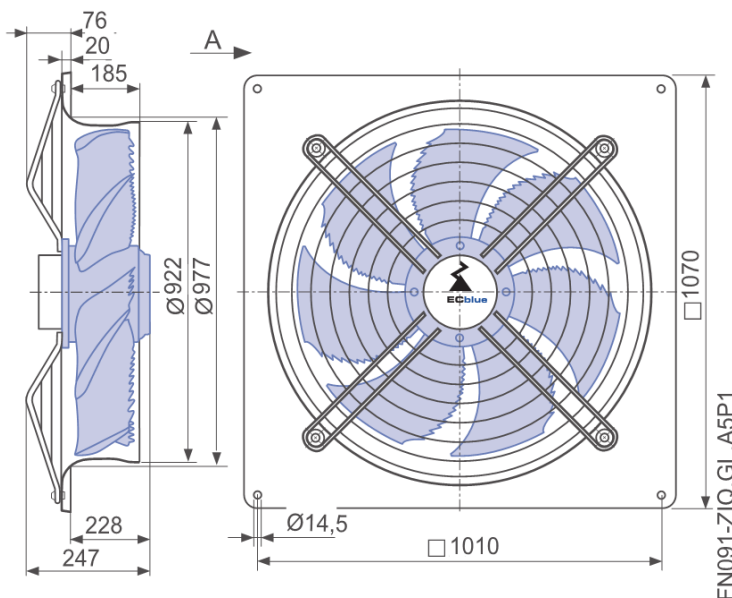

## schéma zapojení

21. 4. 2020

verze FANselect V 1.01 (200311), AMCA V 1.03 February, 2019 / 1.20.03.11 | 541 |

1



**FN091-ZIQ.GL.A5P1**

183920

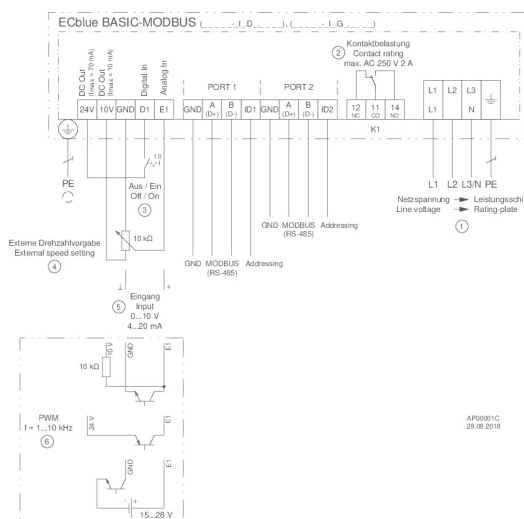



příslušenství

verze FANselect V 1.01 (200311), AMCA V 1.03 February, 2019 / 1.20.03.11 | 541 |

21. 4. 2020

1



typ	<b>FN091-ZIQ.GL.A5P1</b>
artiklové č.	183920