

Datasheet

Product type: **Wire protection grille**
 Product ID: 154062
 Product name: SGE 355

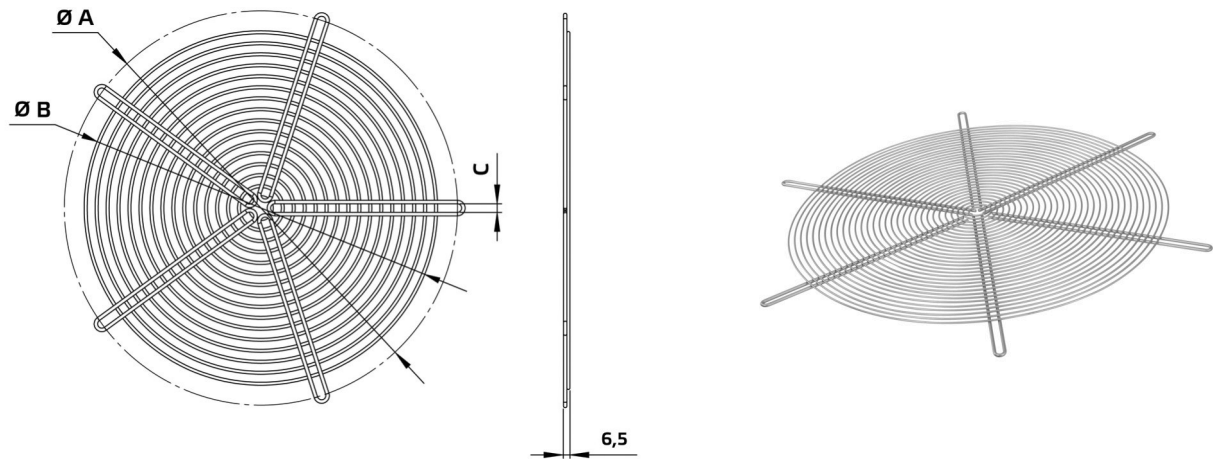

A	mm	395
B	mm	355
C	mm	8
Weight	kg	0.7

- Tight mesh
- Sheet steel, galvanized
- Flange mounting
- When using the protective grille in conjunction with the inlet nozzle, one size larger must be used for the protective grille

Use:

- AL 355 D4 01
- AL 355 D2 01
- AL 355 EC 01