

data ventilátoru

21. 4. 2020

verze FANselect V 1.01 (200311), AMCA V 1.03 February, 2019 / 1.20.03.11 | 541 |

1



typ	FN100-ZIQ.GL.A5P1
artiklové č.	183971 Portfolio STD-WW

technická data

motor		ECblue
napájení	-	3~ 400V 50Hz
maximální okolní teplota (t_r)	°C	65
účinnost η_{statA}	%	48,7
účinnost N_{actual} N_{SOLL}		52,7 40
ErP - třída		2015 EC regulátor integrovaný
grille influence		pressure side measured

data ventilátoru

otáčky ventilátoru (n) max. (n_{max})	1/min	- 850
frekvence v prac.bodě (f_{DP}) (f_{max})	Hz	50 60
hmotnost výrobku (m_{Pr})	kg	60.2
zástavbové rozměry zohledněny (\bar{S} x V x H)	mm	1870 x 1230 x 2000

PF:PF_50; Ano:183971; STol:+-10 %



charakteristika / hlučnost

21. 4. 2020

verze FANselect V 1.01 (200311), AMCA V 1.03 February, 2019 / 1.20.03.11 | 541 |

1

FN100-ZIQ.GLA5P1

Measured in full nozzle with pressure side guard grille in air flow direction V in installation type A according to ISO5801

183971 | Portfolio STD-WW

měřená hustota 1.16 [kg/m³]

vzduchový výkon p_{sF}

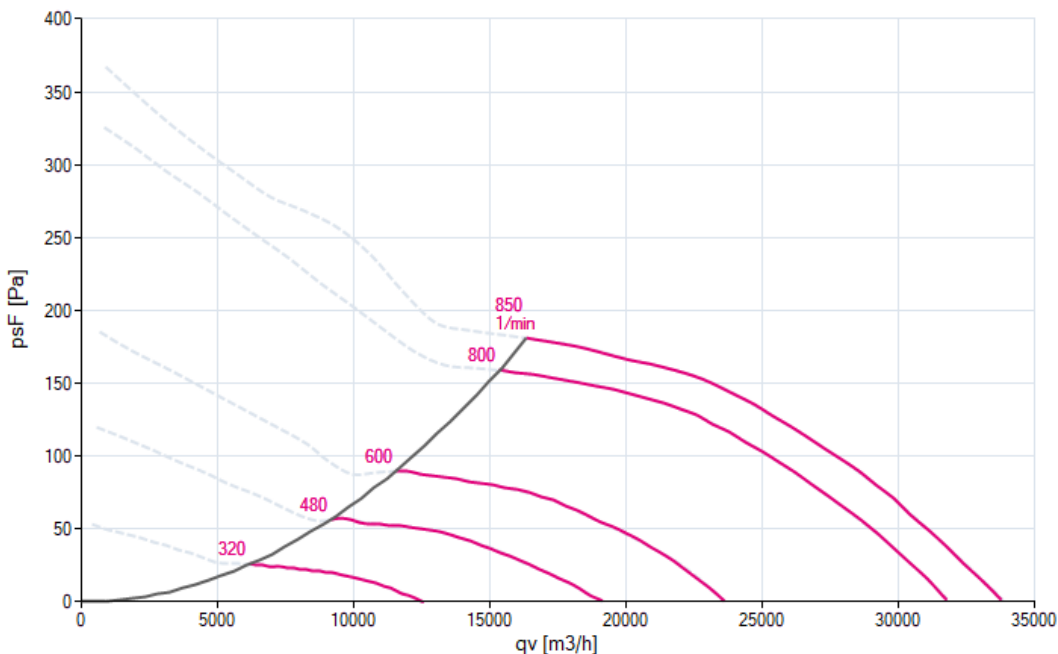

hlučnost (L_{w(A),5})

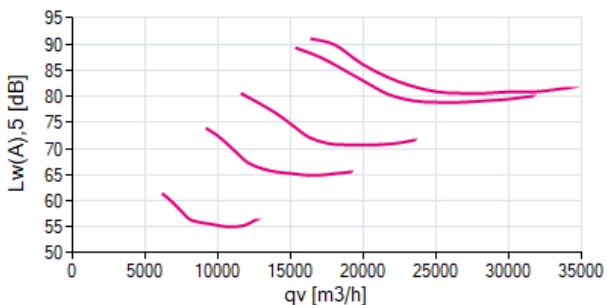

hlučnost (L_{w(A),6})

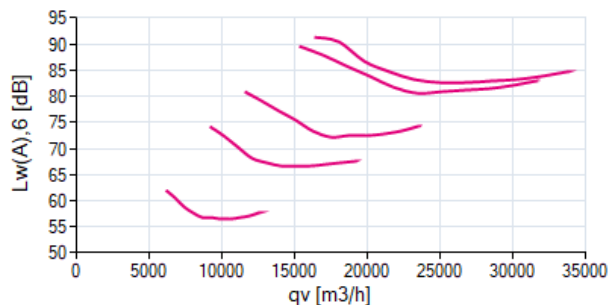

1 FN100-ZIQ.GLA5P1

f [Hz]	sum	63	125	250	500	1000	2000	4000	8000
L _{w(A),5}	-	-	-	-	-	-	-	-	-
L _{w,5}	-	-	-	-	-	-	-	-	-

f [Hz]	sum	63	125	250	500	1000	2000	4000	8000
L _{w(A),6}	-	-	-	-	-	-	-	-	-
L _{w,6}	-	-	-	-	-	-	-	-	-

1

FN100-ZIQ.GLA5P1

Measured in full nozzle with pressure side guard grille in air flow direction V in installation type A according to ISO5801

183971 | Portfolio STD-WW

měřená hustota 1.16 [kg/m³]

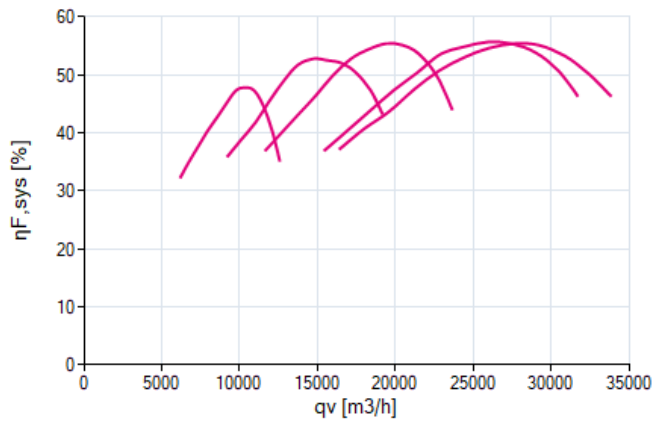
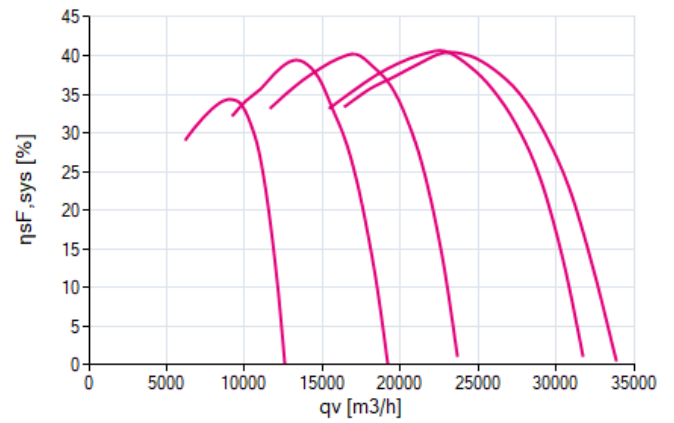
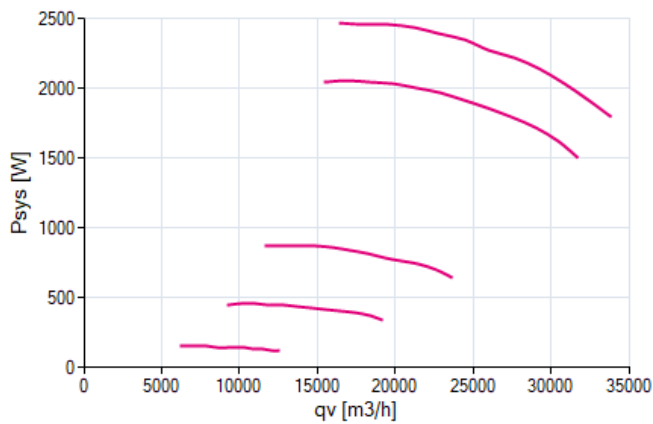
účinnost $\eta_{F,sys}$ účinnost $\eta_{SF,sys}$ příkon P_{sys} 



nominální hodnoty

21. 4. 2020

verze FANselect V 1.01 (200311), AMCA V 1.03 February, 2019 / 1.20.03.11 | 541 |

1



FN100-ZIQ.GL.A5P1

183971

3~ 380-480V 50Hz P1 2.50kW
 4.00-3.20A 850/MIN 65°C
 3~ 380-480V 60Hz P1 2.50kW
 4.00-3.20A 850/MIN 65°C
 IP55 THCL155

výkres

21. 4. 2020

verze FANselect V 1.01 (200311), AMCA V 1.03 February, 2019 / 1.20.03.11 | 541 |

1



FN100-ZIQ.GL.A5P1

183971



schéma zapojení

21. 4. 2020

verze FANselect V 1.01 (200311), AMCA V 1.03 February, 2019 / 1.20.03.11 | 541 |

1

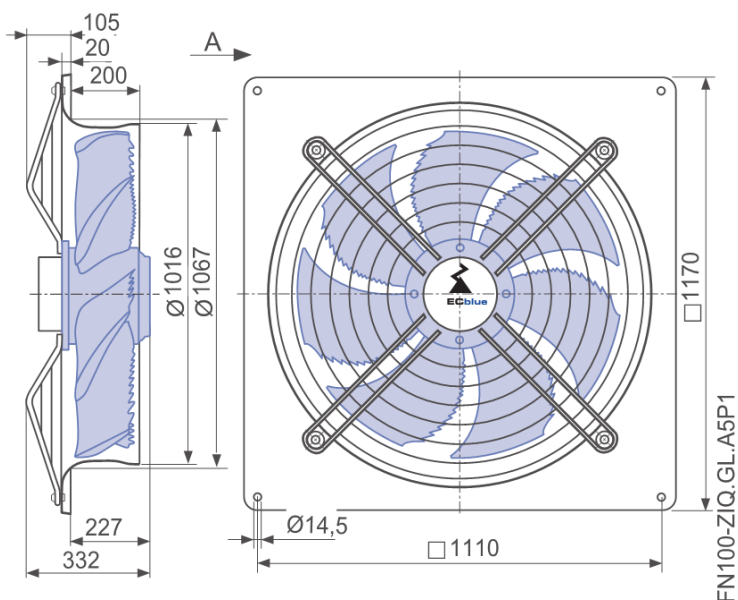

FN100-ZIQ.GL.A5P1

183971

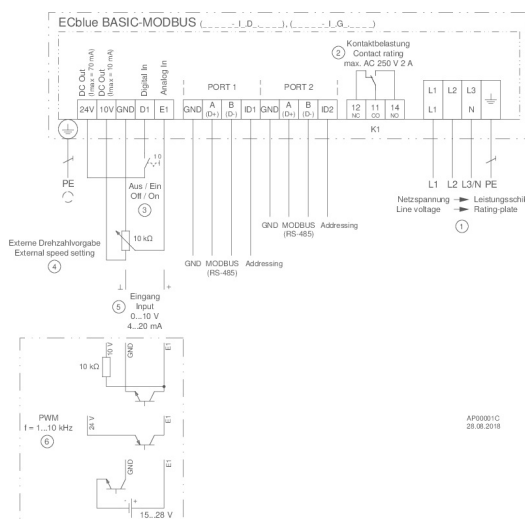



příslušenství

verze FANselect V 1.01 (200311), AMCA V 1.03 February, 2019 / 1.20.03.11 | 541 |

21. 4. 2020

1



typ

FN100-ZIQ.GL.A5P1

artiklové č.

183971