



## data ventilátoru

21. 4. 2020  
verze FANselect V 1.01 (200311), AMCA V 1.03 February, 2019 / 1.20.03.11 | 541 |

typ	FN045-6IL.BD.A7P2
artiklové č.	162120   Portfolio STD-WW

## technická data

motor	ECblue
napájení	- 1~ 230V 50Hz
maximální okolní teplota ( $t_r$ )	°C 60
účinnost $\eta_{statA}$	% 45,1
účinnost $N_{actual}$   $N_{SOLL}$	54,1   40
ErP - třída	2015   EC regulátor integrovaný
grille   influence	pressure side   measured

## data ventilátoru

otáčky ventilátoru ( $n$ )   max. ( $n_{max}$ )	1/min	-   1470
frekvence v prac.bodě ( $f_{DP}$ )   ( $f_{max}$ )	Hz	50   60
hmotnost výrobku ( $m_{Pr}$ )	kg	10.6
zástavbové rozměry zohledněny ( $\check{S}$ x V x H)	mm	1870 x 1230 x 2000

PF:PF\_50; Ano:162120; STol:±10 %



## charakteristika / hlučnost

21. 4. 2020

verze FANselect V 1.01 (200311), AMCA V 1.03 February, 2019 / 1.20.03.11 | 541 |

**1** FN045-6IL.BD.A7P2  
162120 | Portfolio STD-WW

Measured in full nozzle with pressure side guard grille in air flow direction V in installation type A according to ISO5801  
měřená hustota 1.16 [kg/m<sup>3</sup>]

### vzduchový výkon $p_{sF}$

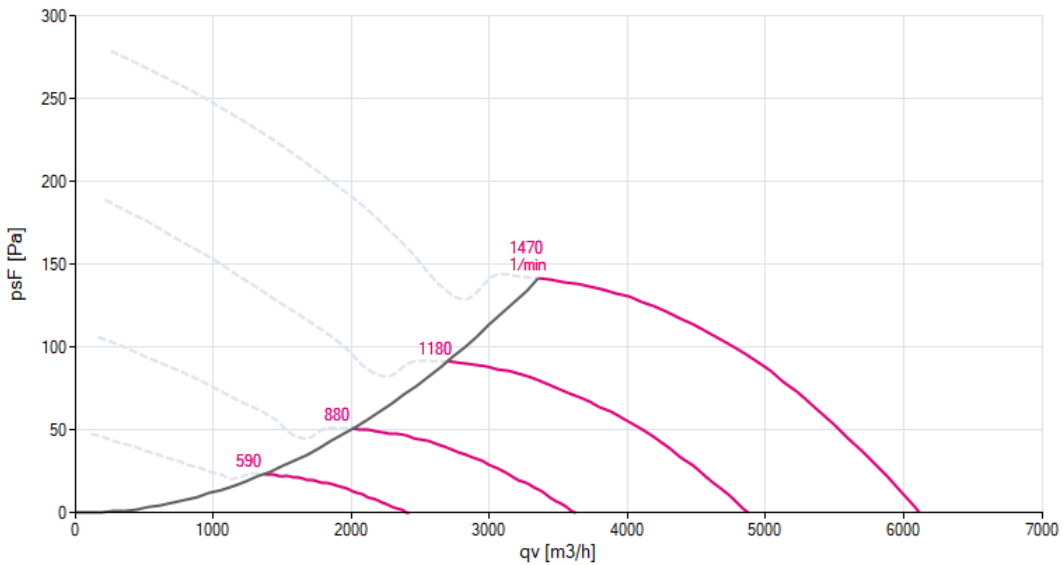

### hlučnost ( $L_{w(A),5}$ )

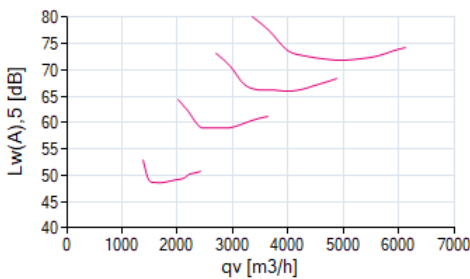

### hlučnost ( $L_{w(A),6}$ )

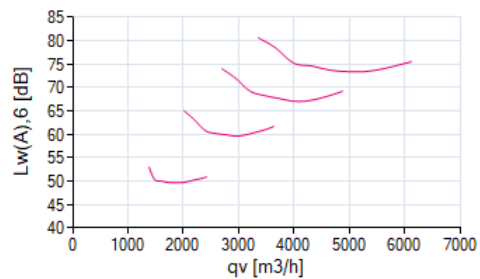

**1** FN045-6IL.BD.A7P2

f [Hz]	sum	63	125	250	500	1000	2000	4000	8000	f [Hz]	sum	63	125	250	500	1000	2000	4000	8000
$L_{w(A),5}$		-	-	-	-	-	-	-	-	$L_{w(A),6}$		-	-	-	-	-	-	-	-
$L_{w,5}$		-	-	-	-	-	-	-	-	$L_{w,6}$		-	-	-	-	-	-	-	-



## účinnost / příkon

21. 4. 2020

verze FANselect V 1.01 (200311), AMCA V 1.03 February, 2019 / 1.20.03.11 | 541 |

1 FN045-6IL.BD.A7P2  
162120 | Portfolio STD-WW

Measured in full nozzle with pressure side guard grille in air flow direction V in installation type A according to ISO5801  
měřená hustota 1.16 [kg/m<sup>3</sup>]

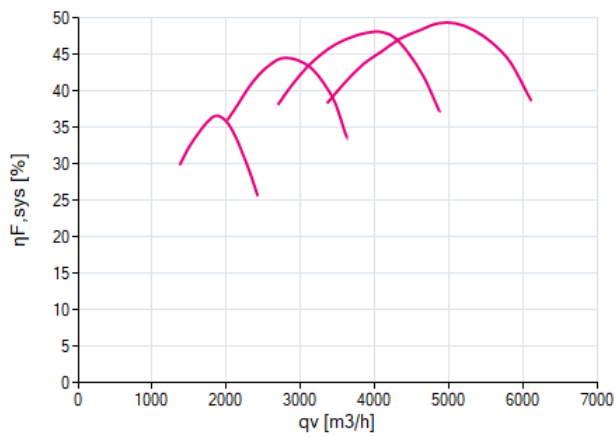
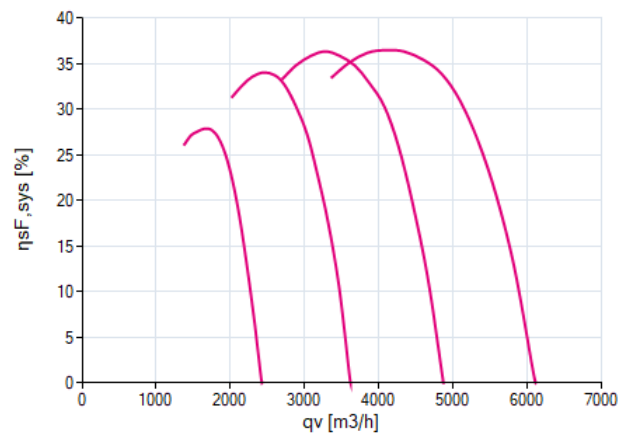
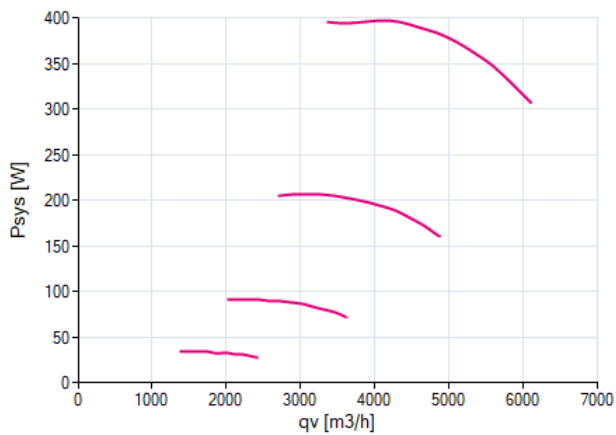
účinnost  $\eta_{F,sys}$ účinnost  $\eta_{sF,sys}$ příkon  $P_{sys}$ 



## nominální hodnoty

21. 4. 2020

verze FANselect V 1.01 (200311), AMCA V 1.03 February, 2019 / 1.20.03.11 | 541 |

1



1" 200-277V 50Hz P1 0.39kW  
 1.95-1.40A 1470/MIN 60°C  
 1" 200-277V 60Hz P1 0.39kW  
 1.95-1.40A 1470/MIN 60°C  
 IP54 THCL155

**FN045-6IL.BD.A7P2**  
 162120

## výkres

21. 4. 2020

verze FANselect V 1.01 (200311), AMCA V 1.03 February, 2019 / 1.20.03.11 | 541 |

1



**FN045-6IL.BD.A7P2**  
 162120

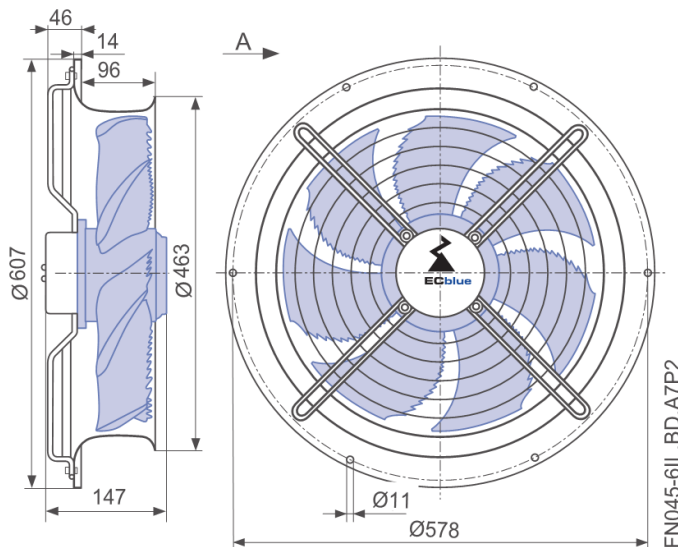

## schéma zapojení

21. 4. 2020

verze FANselect V 1.01 (200311), AMCA V 1.03 February, 2019 / 1.20.03.11 | 541 |

1



**FN045-6IL.BD.A7P2**  
 162120

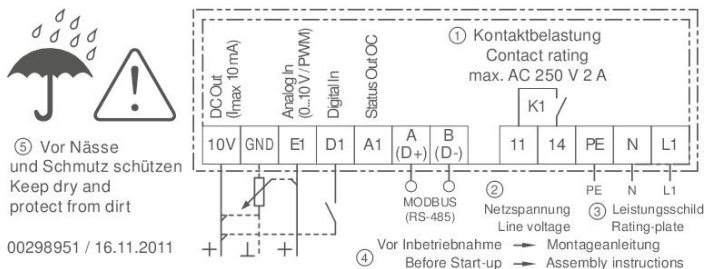



příslušenství

21. 4. 2020

verze FANselect V 1.01 (200311), AMCA V 1.03 February, 2019 / 1.20.03.11 | 541 |



typ

FN045-6IL.BD.A7P2

artiklové č.

162120

**mřížka**

ochranná mřížka proti  
dotyku  
na straně výtlaku  
00286217

