

## data ventilátoru

21. 4. 2020

verze FANselect V 1.01 (200311), AMCA V 1.03 February, 2019 / 1.20.03.11 | 541 |

1



typ	<b>FN063-ZIQ.GL.A7P3</b>
artiklové č.	180823   Portfolio STD-WW

## technická data

motor		ECblue
napájení	-	3~ 400V 50Hz
maximální okolní teplota ( $t_r$ )	°C	65
účinnost $\eta_{statA}$	%	41,7
účinnost $N_{actual}$   $N_{SOLL}$		<b>44,5</b>   40
ErP - třída		2015   EC regulátor integrovaný
grille   influence		pressure side   measured

## data ventilátoru

otáčky ventilátoru ( $n$ )   max. ( $n_{max}$ )	1/min	-   1600
frekvence v prac.bodě ( $f_{DP}$ )   ( $f_{max}$ )	Hz	<b>50</b>   60
hmotnost výrobku ( $m_{Pr}$ )	kg	43.7
zástavbové rozměry zohledněny ( $\bar{S}$ x V x H)	mm	1870 x 1230 x 2000

PF:PF\_50; Ano:180823; STol:+-10 %



## charakteristika / hlučnost

21. 4. 2020

verze FANselect V 1.01 (200311), AMCA V 1.03 February, 2019 / 1.20.03.11 | 541 |

### 1 FN063-ZIQ.GLA7P3

180823 | Portfolio STD-WW

Measured in full nozzle with pressure side guard grille in air flow direction V in installation type A according to ISO5801

měřená hustota 1.16 [kg/m³]

### vzduchový výkon $p_{sF}$

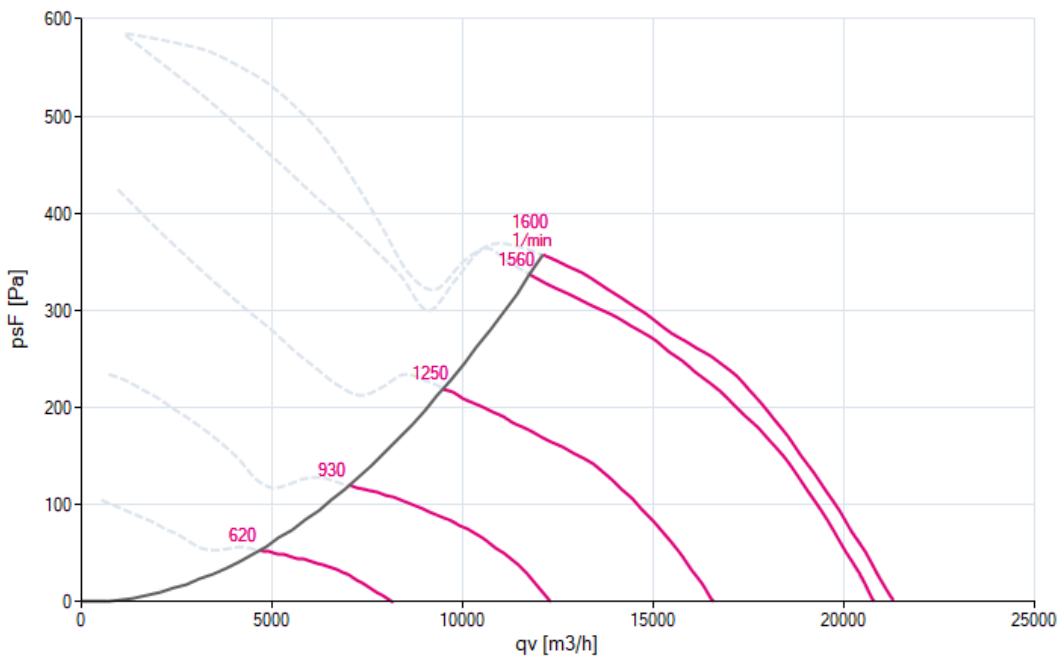

### hlučnost ( $L_{w(A),5}$ )

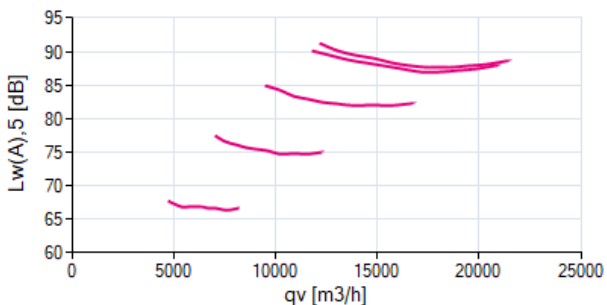

### hlučnost ( $L_{w(A),6}$ )

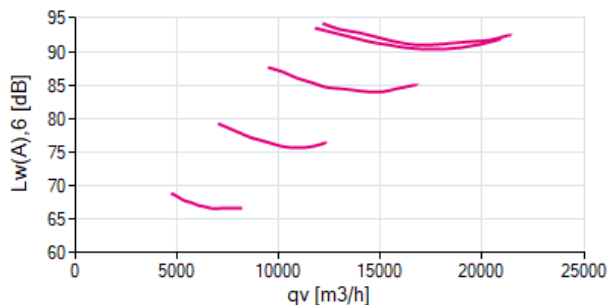

### 1 FN063-ZIQ.GLA7P3

f [Hz]	sum	63	125	250	500	1000	2000	4000	8000
$L_{w(A),5}$	-	-	-	-	-	-	-	-	-
$L_{w,5}$	-	-	-	-	-	-	-	-	-

f [Hz]	sum	63	125	250	500	1000	2000	4000	8000
$L_{w(A),6}$	-	-	-	-	-	-	-	-	-
$L_{w,6}$	-	-	-	-	-	-	-	-	-

1

FN063-ZIQ.GLA7P3

Measured in full nozzle with pressure side guard grille in air flow direction V in installation type A according to ISO5801

180823 | Portfolio STD-WW

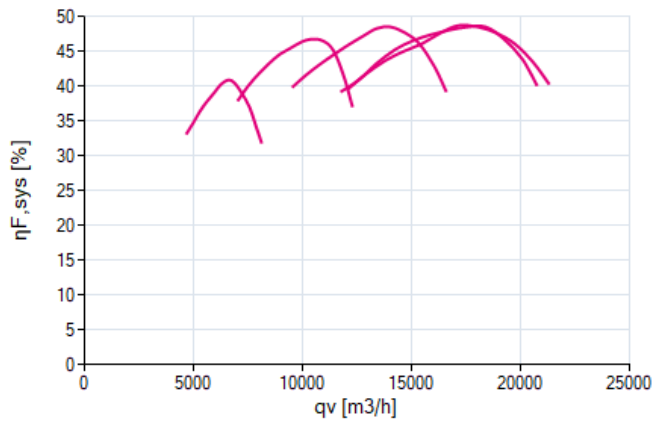
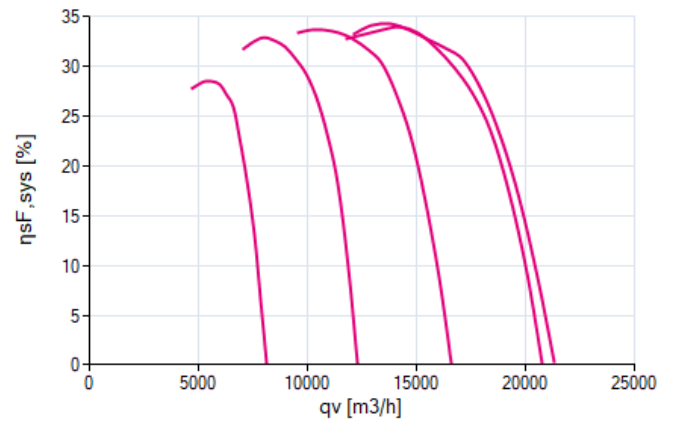
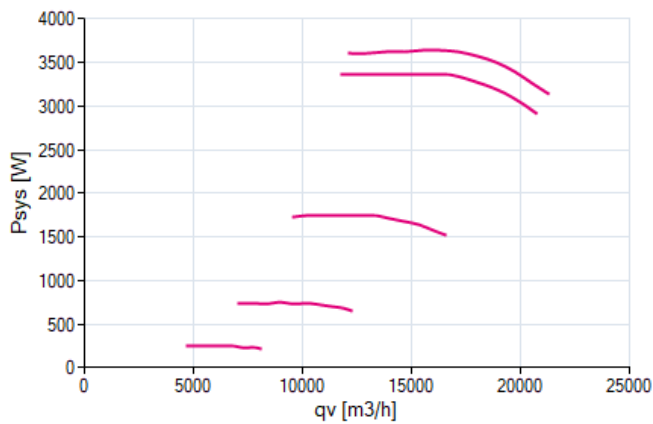
měřená hustota 1.16 [kg/m<sup>3</sup>]účinnost  $\eta_{F,sys}$ účinnost  $\eta_{sF,sys}$ příkon  $P_{sys}$ 



## nominální hodnoty

verze FANselect V 1.01 (200311), AMCA V 1.03 February, 2019 / 1.20.03.11 | 541 |

21. 4. 2020

1



**FN063-ZIQ.GL.A7P3**

180823

3~ 380-480V 50Hz P1 3.70kW  
 5.90-4.70A 1600/MIN 65°C  
 3~ 380-480V 60Hz P1 3.70kW  
 5.90-4.70A 1600/MIN 65°C  
 IP55 THCL155

## výkres

verze FANselect V 1.01 (200311), AMCA V 1.03 February, 2019 / 1.20.03.11 | 541 |

21. 4. 2020

1



**FN063-ZIQ.GL.A7P3**

180823

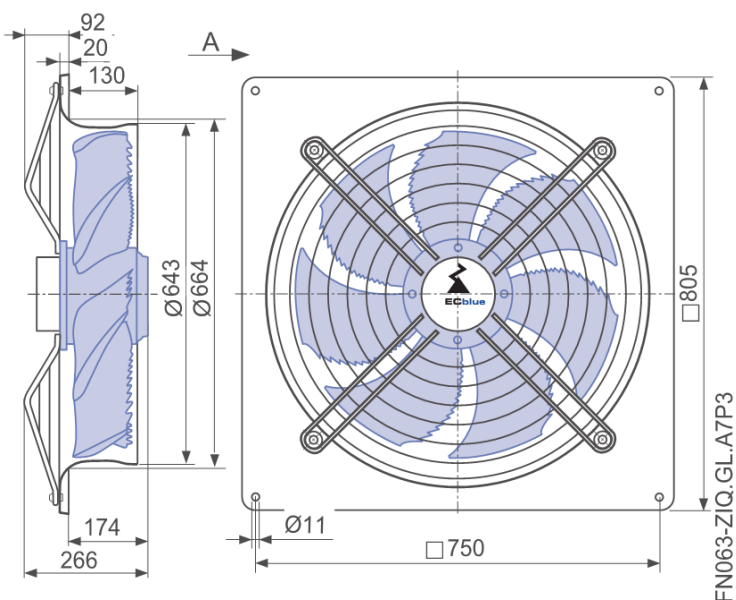

## schéma zapojení

verze FANselect V 1.01 (200311), AMCA V 1.03 February, 2019 / 1.20.03.11 | 541 |

21. 4. 2020

1



**FN063-ZIQ.GL.A7P3**

180823

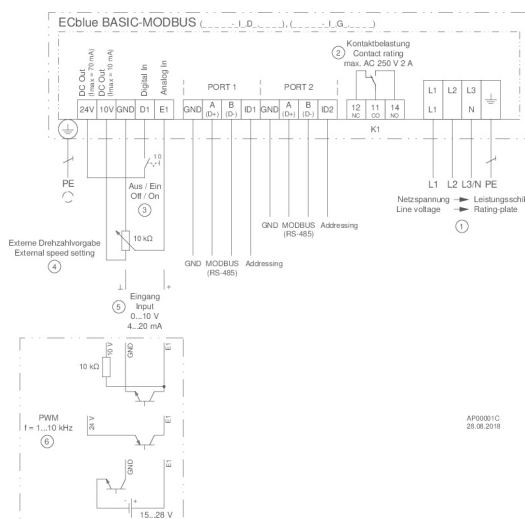



příslušenství

verze FANselect V 1.01 (200311), AMCA V 1.03 February, 2019 / 1.20.03.11 | 541 |

21. 4. 2020

1



typ	<b>FN063-ZIQ.GL.A7P3</b>
artiklové č.	180823