



data ventilátoru

21. 4. 2020
verze FANselect V 1.01 (200311), AMCA V 1.03 February, 2019 / 1.20.03.11 | 541 |

typ

FN040-6IL.BD.A7P1

artiklové č.

162114 | Portfolio STD-WW

technická data

motor		ECblue
napájení	-	1~ 230V 50Hz
maximální okolní teplota (t _r)	°C	60
účinnost η_{statA}	%	49,5
účinnost N_{actual} N_{SOLL}		58,5 40
ErP - třída		2015 EC regulátor integrovaný
grille influence		pressure side measured

data ventilátoru

otáčky ventilátoru (n) max. (n_{max})	1/min	- 1800
frekvence v prac.bodě (f_{DP}) (f_{max})	Hz	50 60
hmotnost výrobku (m_{Pr})	kg	9.5
zástavbové rozměry zohledněny (Š x V x H)	mm	1870 x 1230 x 2000

PF:PF_50; Ano:162114; STol:±10 %



charakteristika / hlučnost

21. 4. 2020

verze FANselect V 1.01 (200311), AMCA V 1.03 February, 2019 / 1.20.03.11 | 541 |

1 FN040-6IL.BD.A7P1
162114 | Portfolio STD-WW

Measured in full nozzle with pressure side guard grille in air flow direction V in installation type A according to ISO5801
měřená hustota 1.16 [kg/m³]

vzduchový výkon p_{sF}

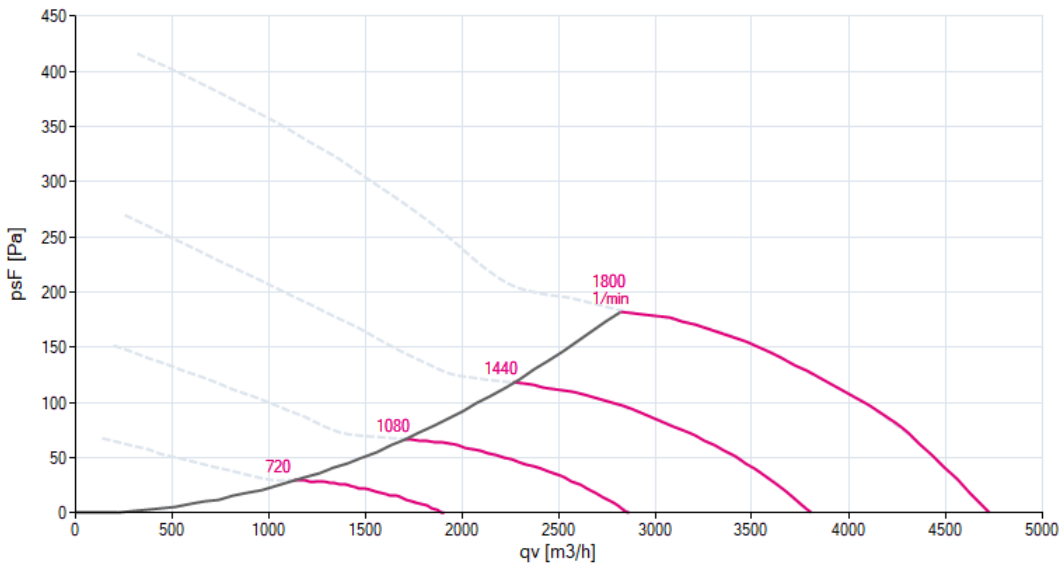

hlučnost ($L_{w(A),5}$)

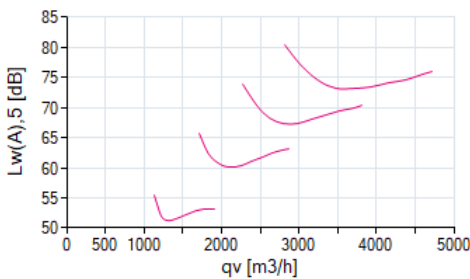

hlučnost ($L_{w(A),6}$)

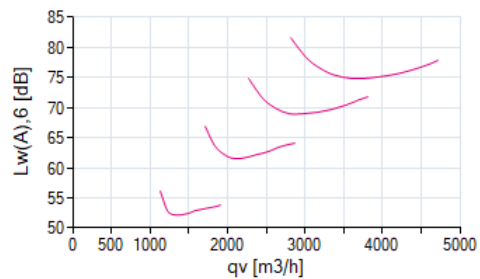

1 FN040-6IL.BD.A7P1																			
f [Hz]	sum	63	125	250	500	1000	2000	4000	8000	f [Hz]	sum	63	125	250	500	1000	2000	4000	8000
$L_{w(A),5}$		-	-	-	-	-	-	-	-	$L_{w(A),6}$		-	-	-	-	-	-	-	-
$L_{w,5}$		-	-	-	-	-	-	-	-	$L_{w,6}$		-	-	-	-	-	-	-	-



účinnost / příkon

21. 4. 2020

verze FANselect V 1.01 (200311), AMCA V 1.03 February, 2019 / 1.20.03.11 | 541 |

1 FN040-6IL.BD.A7P1
162114 | Portfolio STD-WW

Measured in full nozzle with pressure side guard grille in air flow direction V in installation type A according to ISO5801
měřená hustota 1.16 [kg/m³]

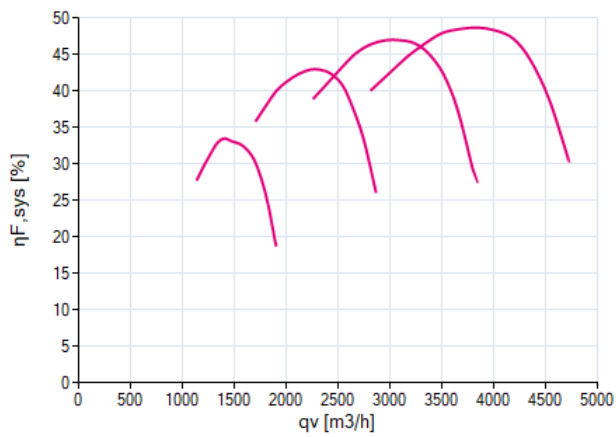
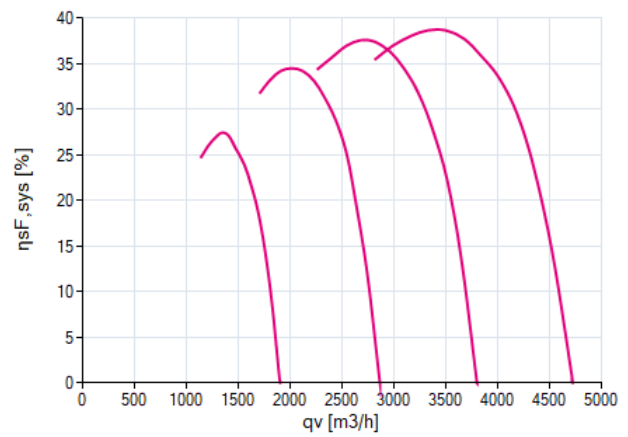
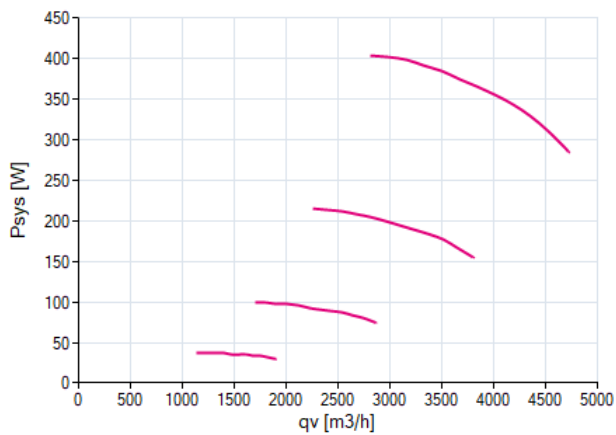
účinnost $\eta_{F,sys}$ účinnost $\eta_{sF,sys}$ příkon P_{sys} 



nominální hodnoty

21. 4. 2020

verze FANselect V 1.01 (200311), AMCA V 1.03 February, 2019 / 1.20.03.11 | 541 |

1



1~ 200-277V 50Hz P1 0.42kW
 2.10-1.50A 1800/MIN 60°C
 1~ 200-277V 60Hz P1 0.42kW
 2.10-1.50A 1800/MIN 60°C
 IP54 THCL155

FN040-6IL.BD.A7P1
162114

výkres

21. 4. 2020

verze FANselect V 1.01 (200311), AMCA V 1.03 February, 2019 / 1.20.03.11 | 541 |

1



FN040-6IL.BD.A7P1
162114



schéma zapojení

21. 4. 2020

verze FANselect V 1.01 (200311), AMCA V 1.03 February, 2019 / 1.20.03.11 | 541 |

1

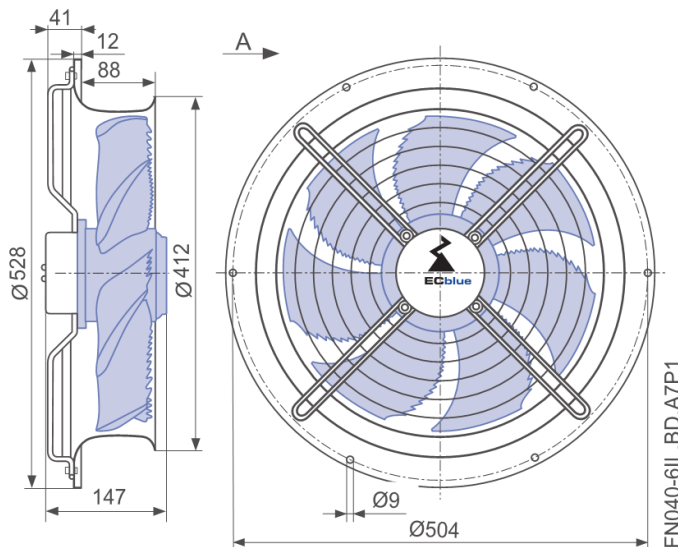

FN040-6IL.BD.A7P1
162114

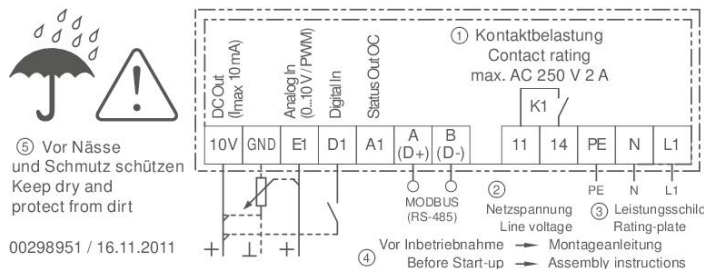



příslušenství

21. 4. 2020

verze FANselect V 1.01 (200311), AMCA V 1.03 February, 2019 / 1.20.03.11 | 541 |



typ

FN040-6IL.BD.A7P1

artiklové č.

162114

mřížka

ochranná mřížka proti
dotyku
na straně výtlaku
00287758