

Datasheet

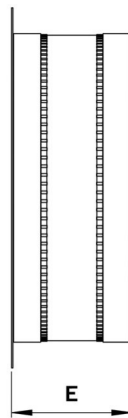

Product type: **Round inlet spigot**
 Product ID: 154302
 Product name: RAS 400 F4

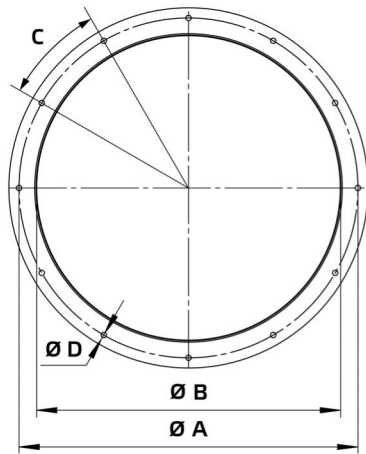

A	mm	450
B	mm	400
C		8 x 45°
D	mm	12
E	mm	105 ... 175
Weight	kg	3.7

- Flexible connection
- Continuous temperature 75°C
- Sheet steel, galvanized
- Silicone band
- Temperature class according to DIN EN 12101-3 F400 (400°C/120min)

Use:

- AL 400 D4 F4 01
- AL 400 D2 F4 01