



## data ventilátoru

21. 4. 2020

verze FANselect V 1.01 (200311), AMCA V 1.03 February, 2019 / 1.20.03.11 | 541 |



typ

FN040-4IL.ZC.A3P6

artiklové č.

178130 | Portfolio STD-WW

## technická data

motor		ECblue
napájení	-	1~ 230V 50Hz
maximální okolní teplota (t <sub>r</sub> )	°C	40
účinnost $\eta_{statA}$	%	48,2
účinnost $N_{actual}$   $N_{SOLL}$		59,8   40
ErP - třída		2015   EC regulátor integrovaný
grille   influence		pressure side   measured

## data ventilátoru

otáčky ventilátoru (n)   max. (n <sub>max</sub> )	1/min	-   1930
frekvence v prac.bodě (f <sub>DP</sub> )   (f <sub>max</sub> )	Hz	50   60
hmotnost výrobku (m <sub>Pr</sub> )	kg	4.4
zástavbové rozměry zohledněny (Š x V x H)	mm	1870 x 1230 x 2000

PF:PF\_50; Ano:178130; STol:±10 %



## charakteristika / hlučnost

21. 4. 2020

verze FANselect V 1.01 (200311), AMCA V 1.03 February, 2019 / 1.20.03.11 | 541 |

**1** FN040-4IL.ZC.A3P6  
178130 | Portfolio STD-WW

Measured in full nozzle with pressure side guard grille in air flow direction V in installation type A according to ISO5801  
měřená hustota 1.16 [kg/m<sup>3</sup>]

### vzduchový výkon $p_{sF}$

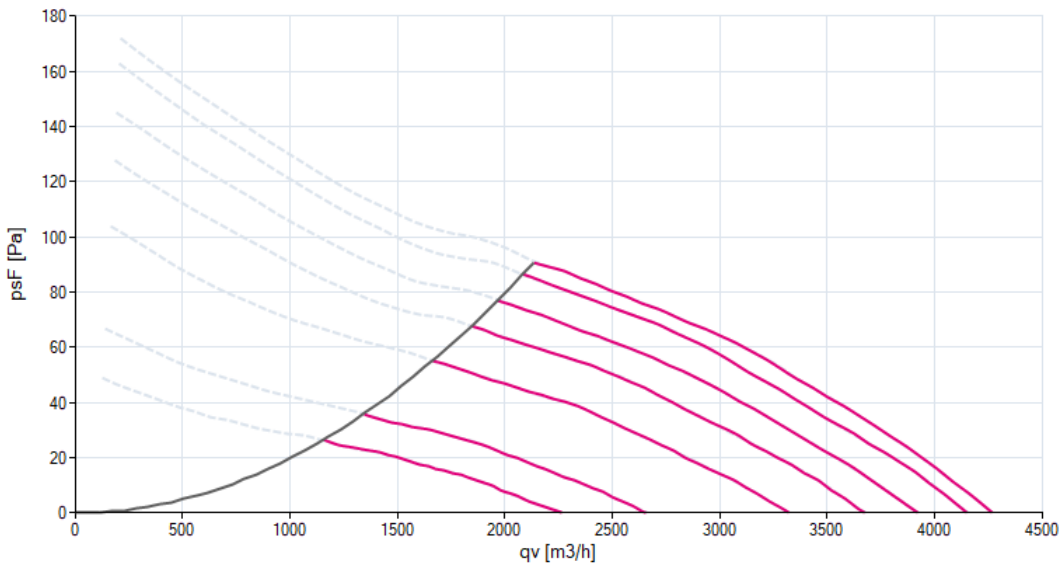

### hlučnost ( $L_{w(A),5}$ )

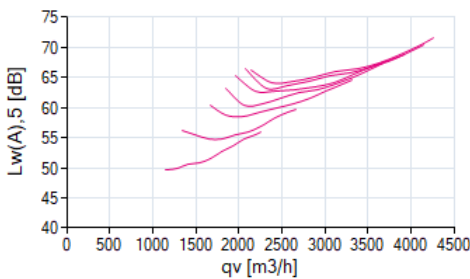

### hlučnost ( $L_{w(A),6}$ )

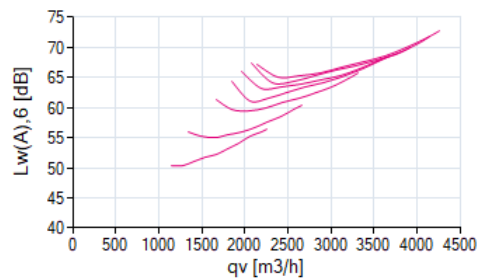

**1** FN040-4IL.ZC.A3P6

f [Hz]	sum	63	125	250	500	1000	2000	4000	8000	f [Hz]	sum	63	125	250	500	1000	2000	4000	8000
$L_{w(A),5}$		-	-	-	-	-	-	-	-	$L_{w(A),6}$		-	-	-	-	-	-	-	-
$L_{w,5}$		-	-	-	-	-	-	-	-	$L_{w,6}$		-	-	-	-	-	-	-	-



## účinnost / příkon

21. 4. 2020

verze FANselect V 1.01 (200311), AMCA V 1.03 February, 2019 / 1.20.03.11 | 541 |

1 FN040-4IL.ZC.A3P6  
178130 | Portfolio STD-WW

Measured in full nozzle with pressure side guard grille in air flow direction V in installation type A according to ISO5801  
měřená hustota 1.16 [kg/m<sup>3</sup>]

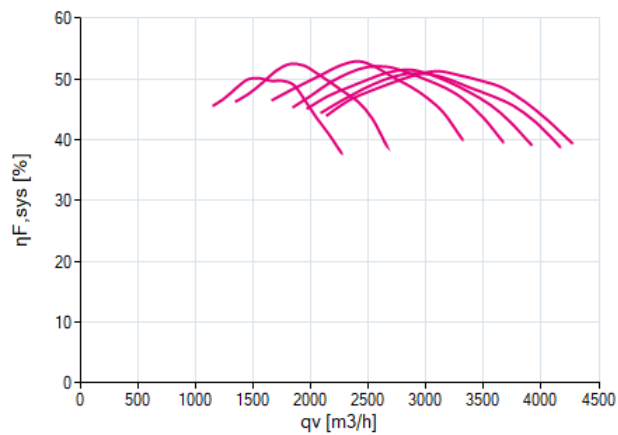
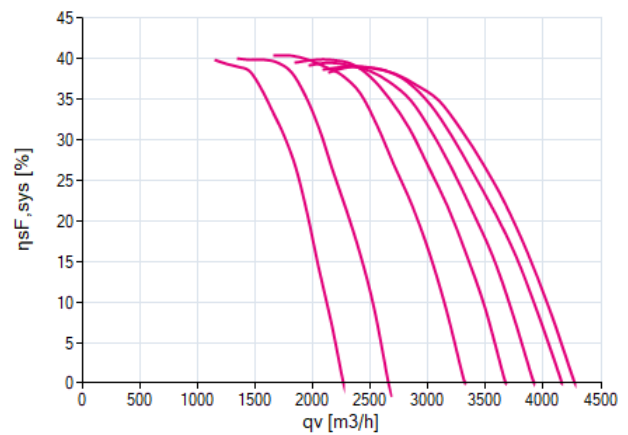
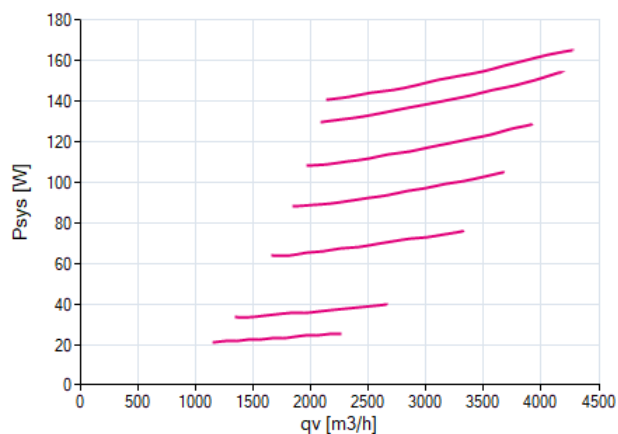
účinnost  $\eta_{F,sys}$ účinnost  $\eta_{sF,sys}$ příkon  $P_{sys}$ 



## nominální hodnoty

21. 4. 2020

verze FANselect V 1.01 (200311), AMCA V 1.03 February, 2019 / 1.20.03.11 | 541 |

1



**FN040-4IL.ZC.A3P6**  
178130

1~ 200-240V 50Hz P1 0.17kW  
1.80-1.50A 1930/MIN 40°C  
1~ 200-240V 60Hz P1 0.17kW  
1.80-1.50A 1930/MIN 40°C  
IP54 THCL155

## výkres

21. 4. 2020

verze FANselect V 1.01 (200311), AMCA V 1.03 February, 2019 / 1.20.03.11 | 541 |

1



**FN040-4IL.ZC.A3P6**  
178130

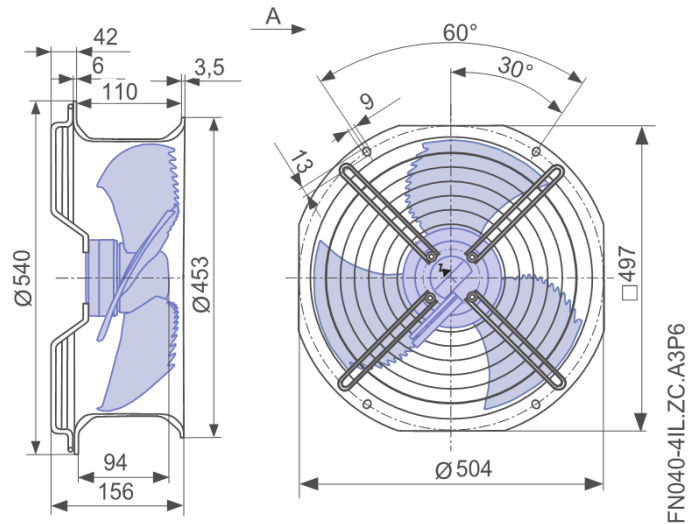

## schéma zapojení

21. 4. 2020

verze FANselect V 1.01 (200311), AMCA V 1.03 February, 2019 / 1.20.03.11 | 541 |

1



**FN040-4IL.ZC.A3P6**  
178130

