

data ventilátoru

17. 4. 2020

verze FANselect V 1.01 (200311), AMCA V 1.03 February, 2019 / 1.20.03.11 | 541 |



typ	ZN080-ZIL.GG.V7P3
artiklové č.	180805 Portfolio STD-WW

technická data

motor		ECblue
napájení	-	3~ 400V 50Hz
maximální okolní teplota (t_r)	°C	70
účinnost η_{statA}	%	57,4
účinnost N_{actual} N_{SOLL}		62,1 40
ErP - třída		2015 EC regulátor integrovaný
grille influence		ne

data ventilátoru

otáčky ventilátoru (n) max. (n_{max})	1/min	- 950
frekvence v prac.bodě (f_{DP}) (f_{max})	Hz	50 60
hmotnost výrobku (m_{Pr})	kg	36.4

PF:PF_50; Ano:180805; STol:++10 %



charakteristika / hlučnost

17. 4. 2020

verze FANselect V 1.01 (200311), AMCA V 1.03 February, 2019 / 1.20.03.11 | 541 |

1 ZN080-ZIL.GG.V7P3

Measured in ZPlus without guard grille in air flow direction V in installation type A according to ISO5801

180805 | Portfolio STD-WW

měřená hustota 1.16 [kg/m³]

vzduchový výkon p_{sF}

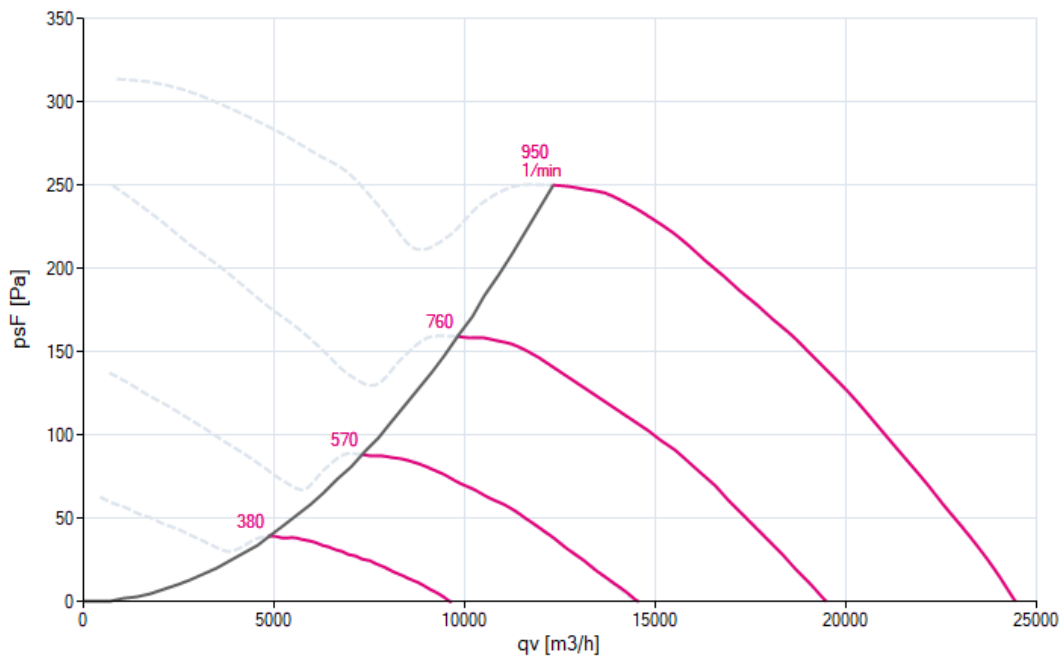

hlučnost ($L_{w(A),5}$)

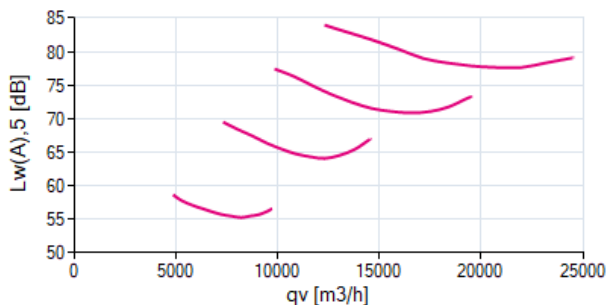

hlučnost ($L_{w(A),6}$)

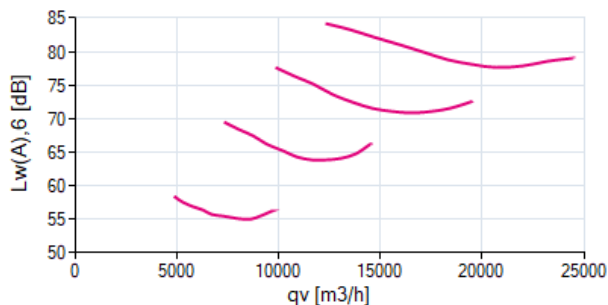

1 ZN080-ZIL.GG.V7P3

f [Hz]	sum	63	125	250	500	1000	2000	4000	8000
$L_{w(A),5}$	-	-	-	-	-	-	-	-	-
$L_{w,5}$	-	-	-	-	-	-	-	-	-

f [Hz]	sum	63	125	250	500	1000	2000	4000	8000
$L_{w(A),6}$	-	-	-	-	-	-	-	-	-
$L_{w,6}$	-	-	-	-	-	-	-	-	-

1

ZN080-ZIL.GG.V7P3

Measured in ZPlus without guard grille in air flow direction V in installation type A according to ISO5801

180805 | Portfolio STD-WW

měřená hustota 1.16 [kg/m³]

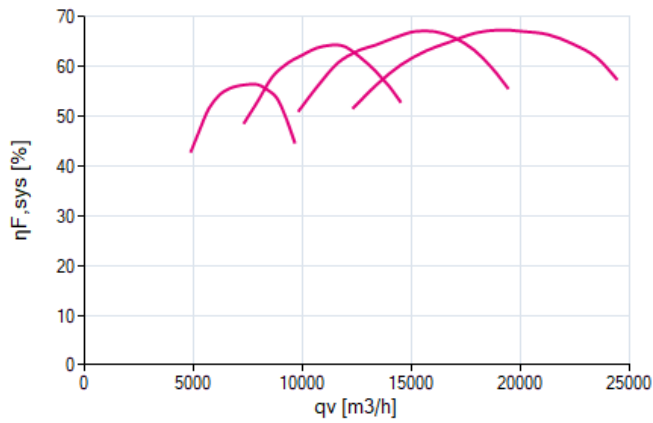
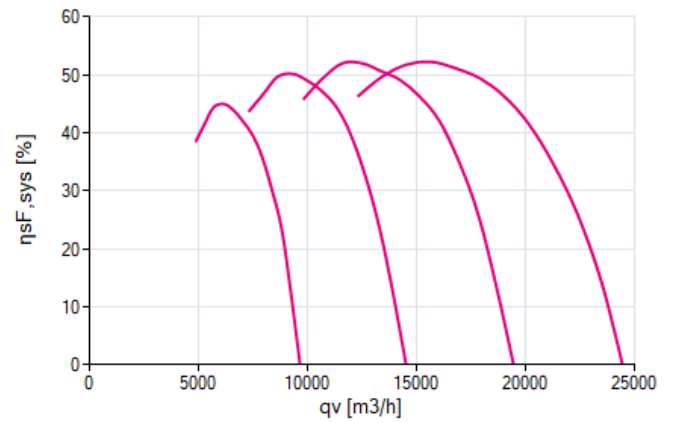
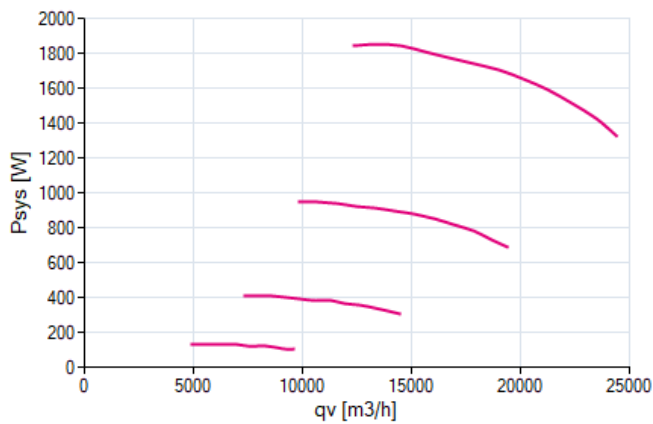
účinnost $\eta_{F,sys}$ účinnost $\eta_{sF,sys}$ příkon P_{sys} 



nominální hodnoty

verze FANselect V 1.01 (200311), AMCA V 1.03 February, 2019 / 1.20.03.11 | 541 |

17. 4. 2020

1



ZN080-ZIL.GG.V7P3

180805

3~ 380-480V 50Hz P1 1.85kW
 3.00-2.40A 950/MIN 70°C
 3~ 380-480V 60Hz P1 1.85kW
 3.00-2.40A 950/MIN 70°C
 IP55 THCL155

výkres

verze FANselect V 1.01 (200311), AMCA V 1.03 February, 2019 / 1.20.03.11 | 541 |

17. 4. 2020

1



ZN080-ZIL.GG.V7P3

180805



schéma zapojení

verze FANselect V 1.01 (200311), AMCA V 1.03 February, 2019 / 1.20.03.11 | 541 |

17. 4. 2020

1

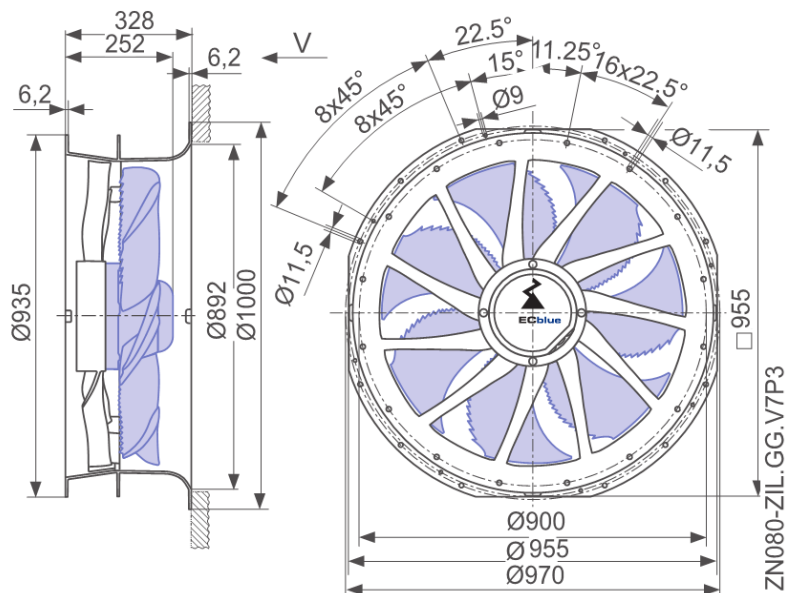

ZN080-ZIL.GG.V7P3

180805

