

Datasheet

Product type: **Round inlet spigot**
Product ID: 154308
Product name: RAS 630 F4

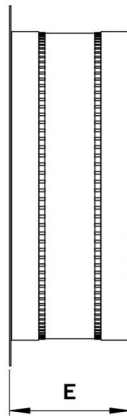
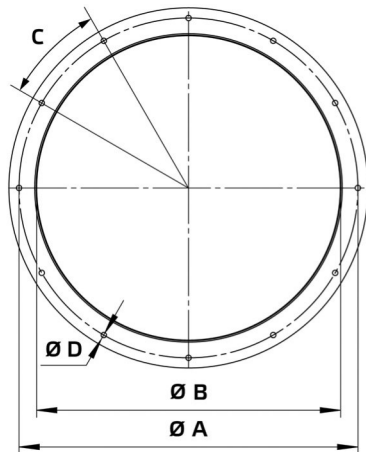

A	mm	690
B	mm	630
C		12 x 30°
D	mm	12
E	mm	153 ... 223
Weight	kg	7.4

- Flexible connection
- Continuous temperature 75°C
- Sheet steel, galvanized
- Silicone band
- Temperature class according to DIN EN 12101-3 F400 (400°C/120min)

Use:

- AL 630 D6 F4 01
- AL 630 D4 F4 01