

data ventilátoru

21. 4. 2020

verze FANselect V 1.01 (200311), AMCA V 1.03 February, 2019 / 1.20.03.11 | 541 |

1



typ	FN080-ZIQ.GL.A7P3
artiklové č.	180855 Portfolio STD-WW

technická data

motor		ECblue
napájení	-	3~ 400V 50Hz
maximální okolní teplota (t_r)	°C	65
účinnost η_{statA}	%	48,2
účinnost N_{actual} N_{SOLL}		51,6 40
ErP - třída		2015 EC regulátor integrovaný
grille influence		pressure side measured

data ventilátoru

otáčky ventilátoru (n) max. (n_{max})	1/min	- 1100
frekvence v prac.bodě (f_{DP}) (f_{max})	Hz	50 60
hmotnost výrobku (m_{Pr})	kg	53.5
zástavbové rozměry zohledněny (\bar{S} x V x H)	mm	1870 x 1230 x 2000

PF:PF_50; Ano:180855; STol:+-10 %



charakteristika / hlučnost

21. 4. 2020

verze FANselect V 1.01 (200311), AMCA V 1.03 February, 2019 / 1.20.03.11 | 541 |

1 FN080-ZIQ.GL.A7P3

Measured in full nozzle with pressure side guard grille in air flow direction V in installation type A according to ISO5801

180855 | Portfolio STD-WW

měřená hustota 1.16 [kg/m³]

vzduchový výkon p_{sF}

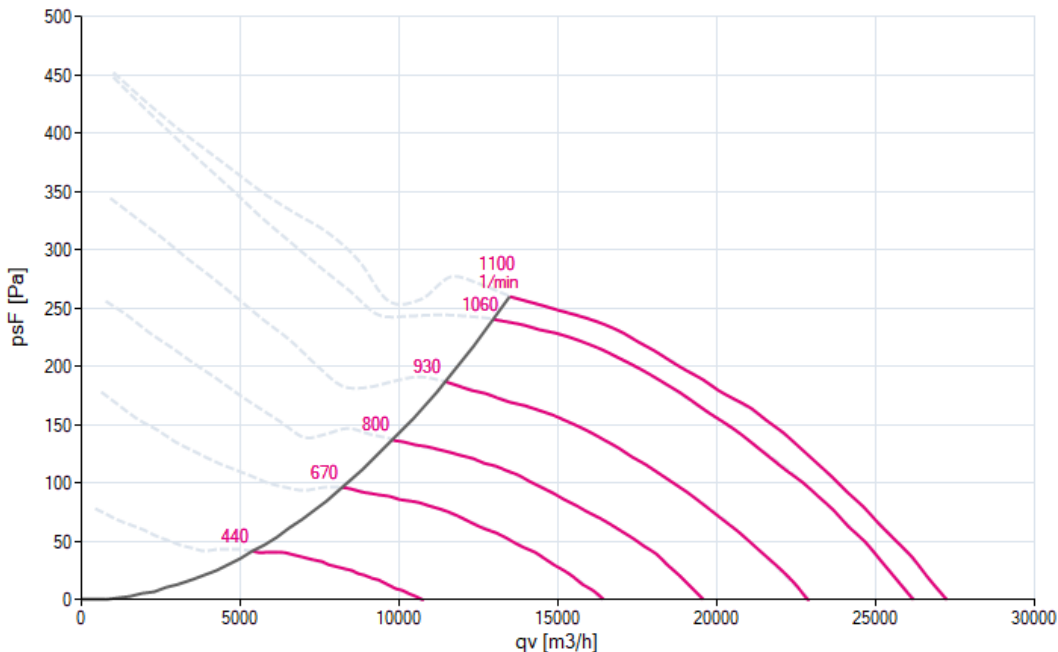

hlučnost ($L_{w(A),5}$)

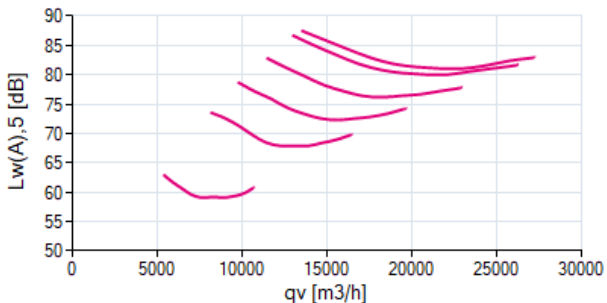

hlučnost ($L_{w(A),6}$)

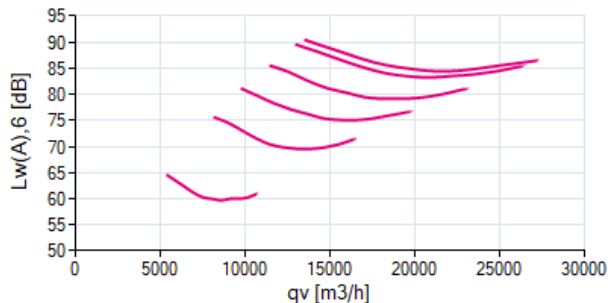

1 FN080-ZIQ.GL.A7P3

f [Hz]	sum	63	125	250	500	1000	2000	4000	8000
$L_{w(A),5}$	-	-	-	-	-	-	-	-	-
$L_{w,5}$	-	-	-	-	-	-	-	-	-

f [Hz]	sum	63	125	250	500	1000	2000	4000	8000
$L_{w(A),6}$	-	-	-	-	-	-	-	-	-
$L_{w,6}$	-	-	-	-	-	-	-	-	-

1

FN080-ZIQ.GLA7P3

Measured in full nozzle with pressure side guard grille in air flow direction V in installation type A according to ISO5801

180855 | Portfolio STD-WW

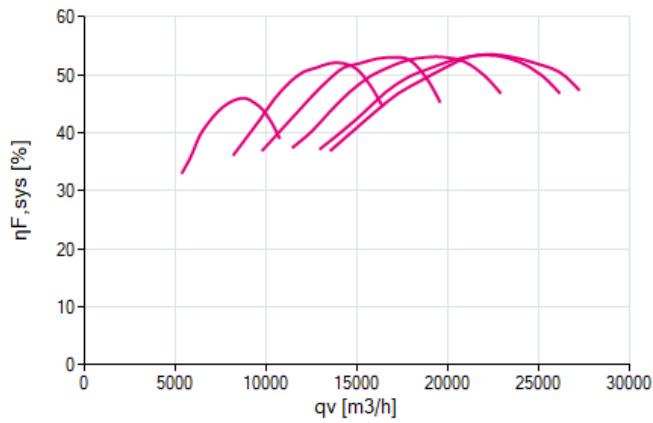
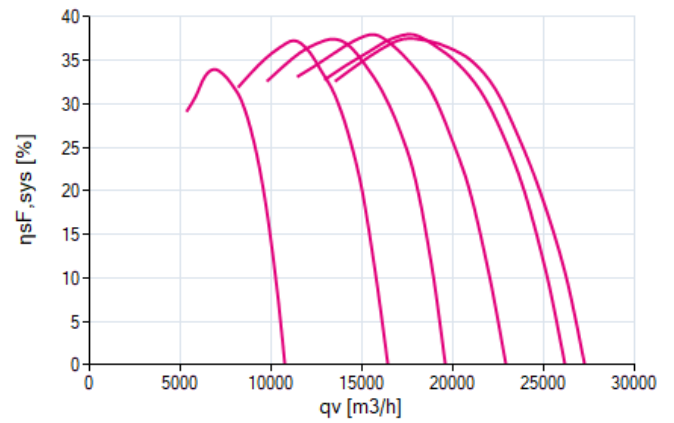
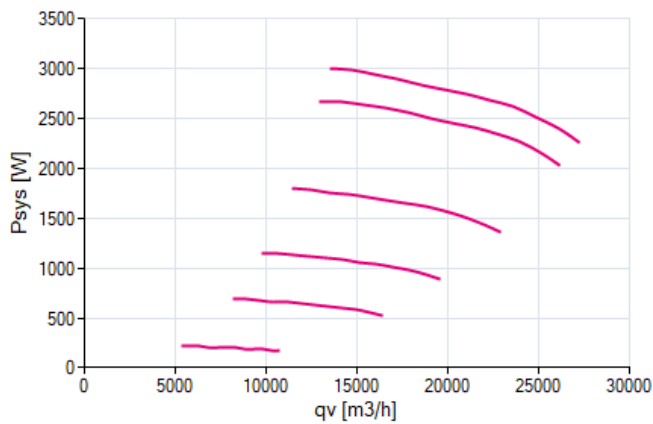
měřená hustota 1.16 [kg/m³]účinnost $\eta_{F,sys}$ účinnost $\eta_{SF,sys}$ příkon P_{sys} 



nominální hodnoty

21. 4. 2020

verze FANselect V 1.01 (200311), AMCA V 1.03 February, 2019 / 1.20.03.11 | 541 |

1



FN080-ZIQ.GL.A7P3

180855

3~ 380-480V 50Hz P1 3.10kW
 4.80-3.80A 1100/MIN 65°C
 3~ 380-480V 60Hz P1 3.10kW
 4.80-3.80A 1100/MIN 65°C
 IP55 THCL155

výkres

21. 4. 2020

verze FANselect V 1.01 (200311), AMCA V 1.03 February, 2019 / 1.20.03.11 | 541 |

1



FN080-ZIQ.GL.A7P3

180855



schéma zapojení

21. 4. 2020

verze FANselect V 1.01 (200311), AMCA V 1.03 February, 2019 / 1.20.03.11 | 541 |

1

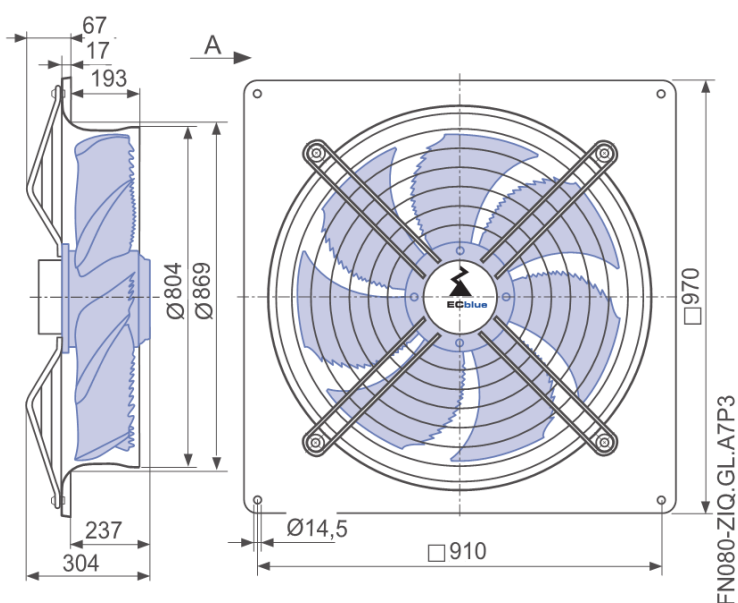

FN080-ZIQ.GL.A7P3

180855

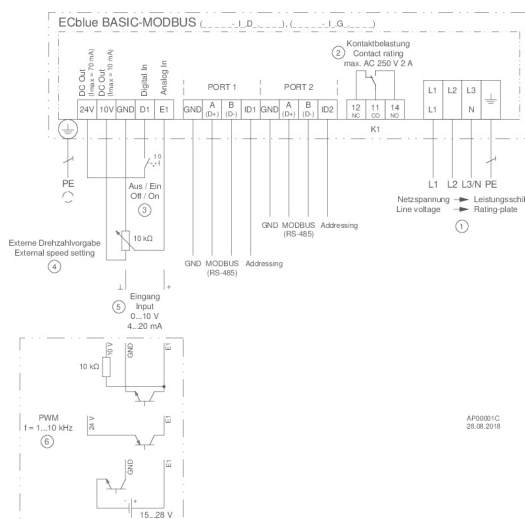



příslušenství

verze FANselect V 1.01 (200311), AMCA V 1.03 February, 2019 / 1.20.03.11 | 541 |

21. 4. 2020

1



typ

FN080-ZIQ.GL.A7P3

artiklové č.

180855