

data ventilátoru

21. 4. 2020

verze FANselect V 1.01 (200311), AMCA V 1.03 February, 2019 / 1.20.03.11 | 541 |

1



typ	FN050-ZIQ.DC.A7P2
artiklové č.	178934 Portfolio STD-WW

technická data

motor		ECblue
napájení	-	3~ 400V 50Hz
maximální okolní teplota (t_r)	°C	70
účinnost η_{statA}	%	41,8
účinnost N_{actual} N_{SOLL}		48,1 40
ErP - třída		2015 EC regulátor integrovaný
grille influence		pressure side measured

data ventilátoru

otáčky ventilátoru (n) max. (n_{max})	1/min	- 1550
frekvence v prac.bodě (f_{DP}) (f_{max})	Hz	50 60
hmotnost výrobku (m_{Pr})	kg	18.7
zástavbové rozměry zohledněny (\bar{S} x V x H)	mm	1870 x 1230 x 2000

PF:PF_50; Ano:178934; STol:+-10 %



charakteristika / hlučnost

21. 4. 2020

verze FANselect V 1.01 (200311), AMCA V 1.03 February, 2019 / 1.20.03.11 | 541 |

1 FN050-ZIQ.DC.A7P2

Measured in full nozzle with pressure side guard grille in air flow direction V in installation type A according to ISO5801

178934 | Portfolio STD-WW

měřená hustota 1.16 [kg/m³]

vzduchový výkon p_{sF}

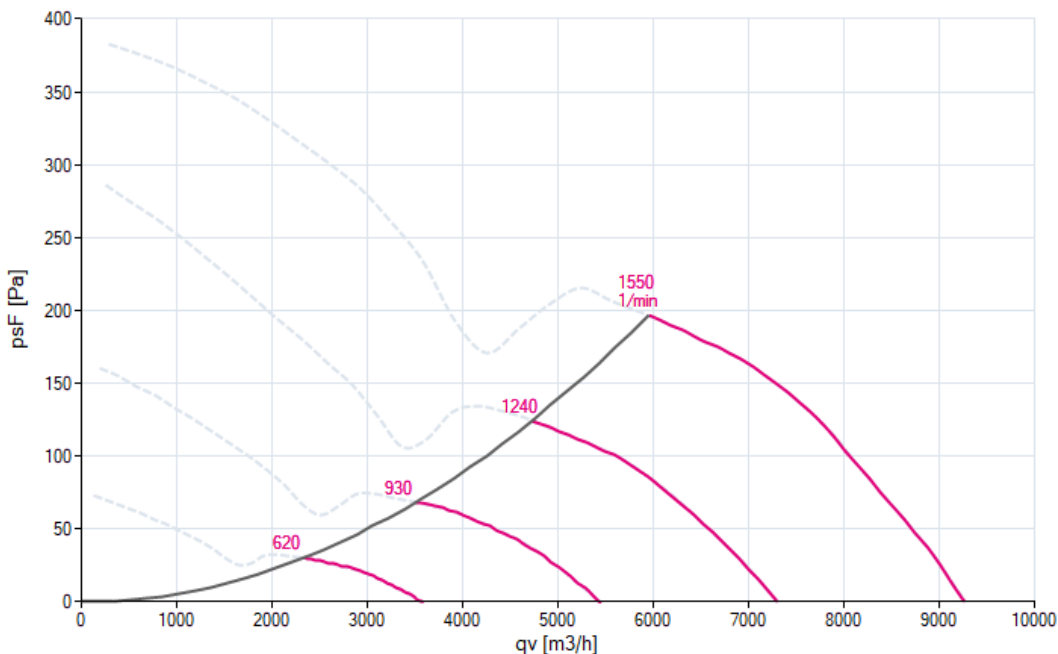

hlučnost ($L_{w(A),5}$)

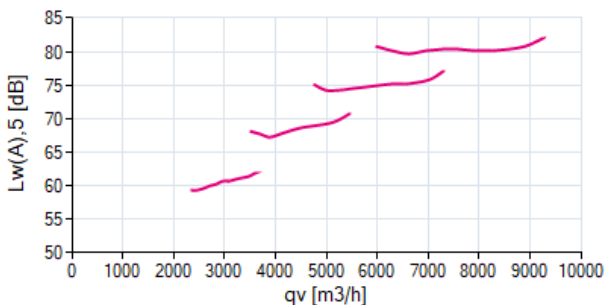

hlučnost ($L_{w(A),6}$)

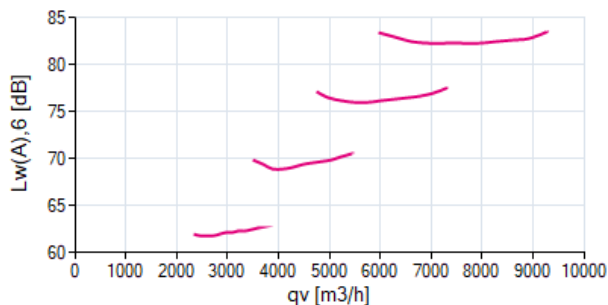

1 FN050-ZIQ.DC.A7P2

f [Hz]	sum	63	125	250	500	1000	2000	4000	8000
$L_{w(A),5}$	-	-	-	-	-	-	-	-	-
$L_{w,5}$	-	-	-	-	-	-	-	-	-

f [Hz]	sum	63	125	250	500	1000	2000	4000	8000
$L_{w(A),6}$	-	-	-	-	-	-	-	-	-
$L_{w,6}$	-	-	-	-	-	-	-	-	-

1

FN050-ZIQ.DC.A7P2

Measured in full nozzle with pressure side guard grille in air flow direction V in installation type A according to ISO5801

178934 | Portfolio STD-WW

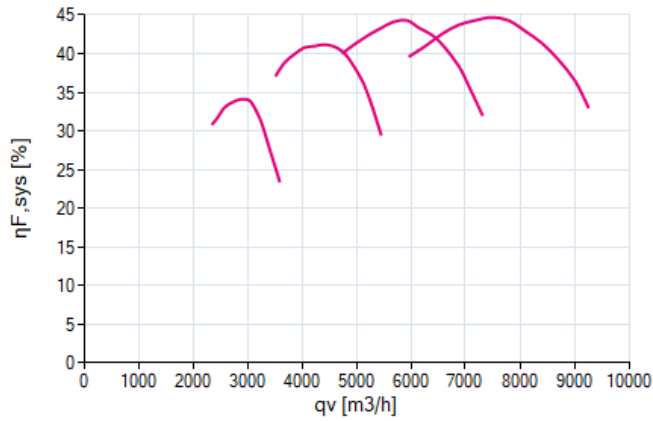
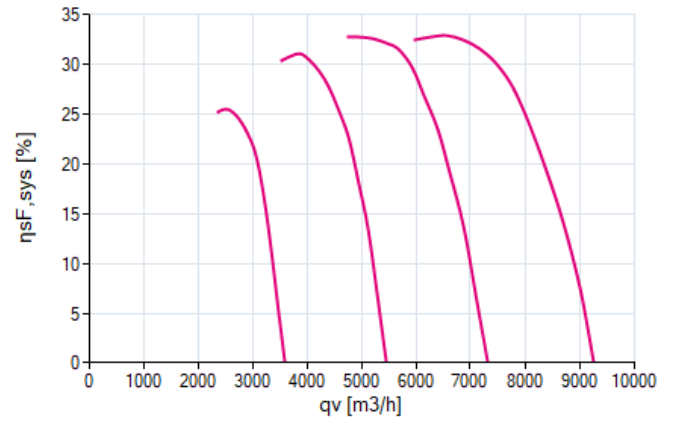
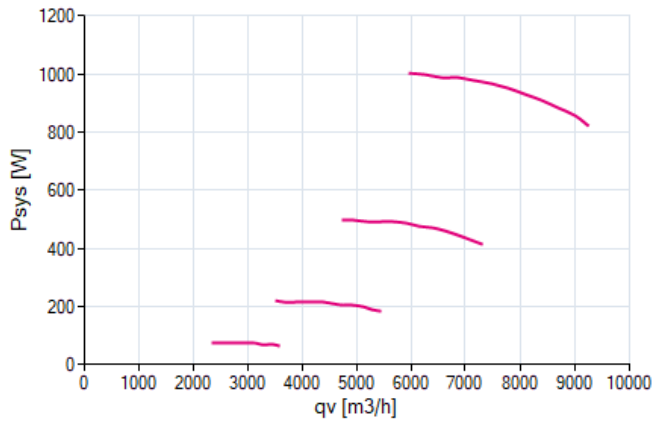
měřená hustota 1.16 [kg/m³]účinnost $\eta_{F,sys}$ účinnost $\eta_{SF,sys}$ příkon P_{sys} 



nominální hodnoty

verze FANselect V 1.01 (200311), AMCA V 1.03 February, 2019 / 1.20.03.11 | 541 |

21. 4. 2020

1



FN050-ZIQ.DC.A7P2

178934

3~ 380-480V 50Hz P1 1.00kW
 1.70-1.35A 1550/MIN 70°C
 3~ 380-480V 60Hz P1 1.00kW
 1.70-1.35A 1550/MIN 70°C
 IP55 THCL155

výkres

verze FANselect V 1.01 (200311), AMCA V 1.03 February, 2019 / 1.20.03.11 | 541 |

21. 4. 2020

1



FN050-ZIQ.DC.A7P2

178934



schéma zapojení

verze FANselect V 1.01 (200311), AMCA V 1.03 February, 2019 / 1.20.03.11 | 541 |

21. 4. 2020

1

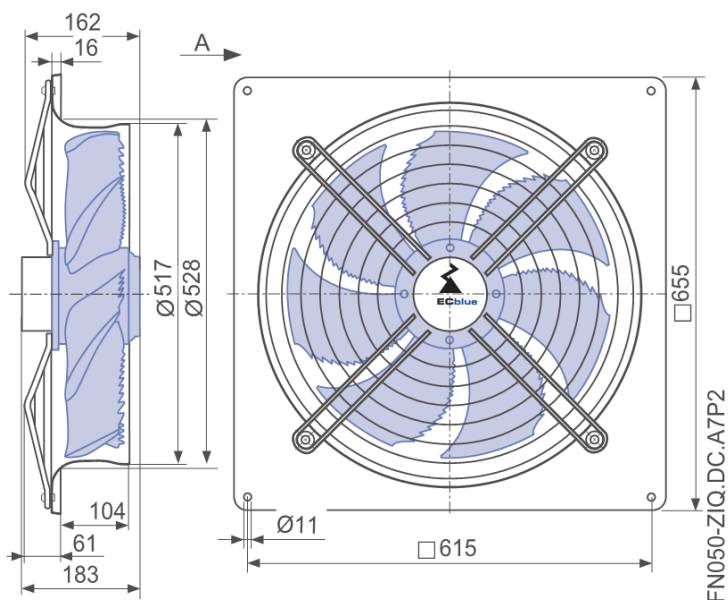

FN050-ZIQ.DC.A7P2

178934

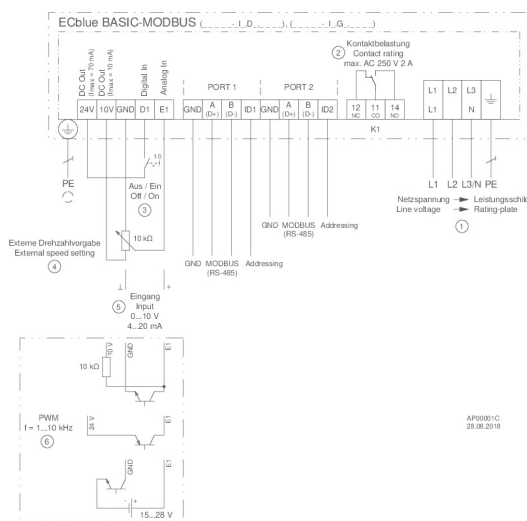



příslušenství

verze FANselect V 1.01 (200311), AMCA V 1.03 February, 2019 / 1.20.03.11 | 541 |

21. 4. 2020

1



typ

FN050-ZIQ.DC.A7P2

artiklové č.

178934